

## High Voltage LED Series Chip on Board

# LC013B



High efficacy COB LED package,  
well-suited for use in spotlight applications

### Features & Benefits

- Chip on Board (COB) solution makes it easy to design in
- Simple assembly reduces manufacturing cost
- Low thermal resistance
- InGaN/GaN MQW LED with long time reliability
- Completed 6,000 hours of LM-80 Testing
- ENEC certified: Integral LED Module

### Applications

- Spotlight / Downlight
- LED Retrofit Bulbs
- Outdoor Illumination



## Table of Contents

1.	Characteristics	-----	3
2.	Product Code Information	-----	6
3.	Typical Characteristics Graphs	-----	13
4.	Outline Drawing & Dimension	-----	18
5.	Reliability Test Items & Conditions	-----	19
6.	Label Structure	-----	20
7.	Packing Structure	-----	22
8.	Precautions in Handling & Use	-----	25

## 1. Characteristics

### a) Absolute Maximum Rating

Item	Symbol	Rating	Unit	Condition
Ambient / Operating Temperature	$T_a$	-40 ~ +105	°C	-
Storage Temperature	$T_{stg}$	-40 ~ +120	°C	-
LED Junction Temperature	$T_j$	150	°C	-
Case Temperature	$T_c$	105	°C	*Note
Forward Current	$I_F$	660	mA	-
Power Dissipation	$P_D$	24.4	W	-
ESD (HBM)	-	±2	kV	-
ESD (MM)	-	±0.5	kV	-

### b) Electro-optical Characteristics ( $I_F = 360 \text{ mA}$ , $T_c = 25 \text{ °C}$ )

Item	Unit	Rank	Min.	Typ.	Max.
Forward Voltage ( $V_f$ )	V	YH	32.5	35.5	38.5
Color Rendering Index ( $R_a$ )	-	3	70	-	-
		5	80	-	-
		7	90	-	-
		8	95	-	-
Thermal Resistance (junction to chip point)	°C/W		-	1.6	-
Beam Angle	°		-	115	-
Working Voltage for Insulation	V				50
Nominal Power	W			12.8	
Eye Protection		Risk 1	-		-

#### Notes:

- 1) The COB is tested in pulsed condition at rated test current (10 ms pulse width) and rated temperature ( $T_j = T_c = T_a = 25 \text{ °C}$ )
- 2) Samsung maintains measurement tolerance of: forward voltage = ±5 %, CRI = ±1
- 3) Max  $T_c=105\text{°C}$  (at max current) is for ENEC condition. Refer to the derating curve, '3. Typical Characteristics Graph' designed within the range.

c) Luminous Flux Characteristics ( $I_F = 360 \text{ mA}$ )

CRI ( $R_a$ ) Min.	Nominal CCT (K)	Flux Rank	Flux Bin	Sorting <sup>1)</sup> @ $T_c = 25^\circ\text{C}$ (lm)		Calculated Flux <sup>2)</sup> @ $T_c = 85^\circ\text{C}$ (lm)	
				Min.	Max.	Min.	Max.
70	3000	1F	11	1633	1856	1470	1670
			12	1856	2078	1670	1871
	4000	1F	11	1715	1948	1543	1754
			12	1948	2182	1754	1964
	5000	1F	11	1731	1967	1558	1770
			12	1967	2203	1770	1983
80	2700	1F	13	1300	1400	1183	1274
			14	1400	1500	1274	1365
			15	1500	1600	1365	1456
			16	1600	1700	1456	1547
			17	1700	1800	1547	1638
			16	1600	1700	1456	1547
	1D	17	1700	1800	1547	1638	
		13	1350	1450	1229	1320	
	3000	1F	14	1450	1550	1320	1411
			15	1550	1650	1411	1502
			16	1650	1750	1502	1593
			17	1750	1850	1593	1684
			16	1650	1750	1502	1593
			17	1750	1850	1593	1684
	1D	14	1400	1510	1274	1374	
		15	1510	1620	1374	1474	
	3500	1F	16	1620	1730	1474	1574
			17	1730	1840	1574	1674
18			1840	1950	1674	1775	
17			1730	1840	1574	1674	
1D			18	1840	1950	1674	1775
			15	1430	1540	1301	1401
4000	1F	16	1540	1650	1401	1502	
		17	1650	1760	1502	1602	
		18	1760	1870	1602	1702	
		19	1870	1980	1702	1802	
		1D	18	1760	1870	1602	1702
			19	1870	1980	1702	1802

c) Luminous Flux Characteristics ( $I_F = 360 \text{ mA}$ )

CRI ( $R_a$ ) Min.	Nominal CCT (K)	Flux Rank	Flux Bin	Sorting <sup>1</sup> @ $T_c = 25 \text{ }^\circ\text{C}$ (lm)		Calculated Flux <sup>2</sup> @ $T_c = 85 \text{ }^\circ\text{C}$ (lm)	
				Min.	Max.	Min.	Max.
80	5000	1F	15	1440	1560	1310	1420
			16	1560	1680	1420	1529
			17	1680	1800	1529	1638
		1D	18	1800	1920	1638	1747
			17	1680	1800	1529	1638
			18	1800	1920	1638	1747
	5700	1F	15	1440	1560	1310	1420
			16	1560	1680	1420	1529
			17	1680	1800	1529	1638
		1D	18	1800	1920	1638	1747
			17	1680	1800	1529	1638
			18	1800	1920	1638	1747
90	2700	1F	12	1175	1290	1069	1174
			13	1290	1405	1174	1279
			14	1405	1520	1279	1383
	3000	1F	12	1200	1320	1092	1201
			13	1320	1440	1201	1310
			14	1440	1560	1310	1420
	3500	1F	12	1235	1355	1124	1233
			13	1355	1475	1233	1342
			14	1475	1595	1342	1451
	4000	1F	12	1270	1395	1156	1269
			13	1395	1520	1269	1383
			14	1520	1645	1383	1497
95	2700	1E	11	1160	1289	1056	1173
			12	1289	1418	1173	1291
	3000	1E	11	1196	1329	1089	1209
			12	1329	1462	1209	1330
	3500	1E	11	1232	1369	1121	1246
			12	1369	1506	1246	1370

**Notes:**

- 1) The COB is tested in pulsed condition at rated test current (10 ms pulse width) and rated temperature ( $T_j = T_c = T_a = 25 \text{ }^\circ\text{C}$ )
- 2) Calculated flux values are for reference only
- 3) Samsung maintains measurement tolerance of: luminous flux =  $\pm 7 \%$ , CRI =  $\pm 1$

## 2. Product Code Information

1	2	3	4	5	6	7	8	9	10	11	12	13	14	15	16	17	18
S	P	H	C	W	1	H	D	N	A	2	5	Y	H	R	T	1	F

Digit	PKG Information	Code	Specification
1 2 3	Samsung Package High Power	<b>SPH</b>	
4 5	Color	<b>WW</b> <b>CW</b>	Warm White (T/U/V/W Ranks) Cool White (Q/R Ranks)
6	Product Version	<b>1</b>	
7 8	Form Factor	<b>HD</b>	COB
9	Lens Type	<b>N</b>	No lens
10	Internal Code	<b>A</b>	LC013
11	Chip Type	<b>2</b>	
12	CRI & Sorting Temperature	<b>3</b> <b>5</b> <b>7</b> <b>8</b>	Min. 70 Min. 80 Min. 90 Min 95 25 °C
13 14	Forward Voltage (V)	<b>YH</b>	32.5~38.5
15	CCT (K)	<b>W</b> <b>V</b> <b>U</b> <b>T</b> <b>R</b> <b>Q</b>	2700 K WA, WB (MacAdam Ellipse) 3000 K VA, VB (MacAdam Ellipse) VW, VX, VY, VZ (ANSI bin) 3500 K UA, UB (MacAdam Ellipse) 4000 K TA, TB (MacAdam Ellipse) 5000 K RA (MacAdam Ellipse) RW, RX, RY, RZ (ANSI bin) 5700 K QW, QX, QY, QZ (ANSI bin)
16	MacAdam / ANSI	<b>2</b> <b>3</b> <b>T</b>	MacAdam 2-step MacAdam 3-step ANSI bin
17 18	Luminous Flux	<b>1E</b> <b>1F</b> <b>1D</b>	11, 12 (95 CRI) Bin Code: 12, 13, 14 (90 CRI); 13, 14, 15, 16, 17, 18 (80 CRI); 11, 12 (70 CRI) 16, 17 (80 CRI), 17, 18 (80 CRI)

a) Binning Structure ( $I_F = 360 \text{ mA}$ ,  $T_c = 25 \text{ }^\circ\text{C}$ )

CRI ( $R_a$ ) Min.	Nominal CCT (K)	Product Code	$V_f$ Rank	Color Rank	Chrom. Bin	Flux Rank	Flux Bin	Flux Range ( $\Phi_v$ , lm)											
70	3000	SPHWW1HDNA23YHVT1F	YH	VT	VV, VX VY, VZ	1F	11	1633 ~ 1856											
							12	1856 ~ 2078											
	4000	SPHWW1HDNA23YHTT1F	YH	TT	TW, TX TY, TZ	1F	11	1715 ~ 1948											
							12	1948 ~ 2182											
	5000	SPHCW1HDNA23YHRT1F	YH	RT	RW, RX RY, RZ	1F	11	1731 ~ 1967											
							12	1967 ~ 2203											
	80	2700	SPHWW1HDNA25YHW21F	YH	W2	WB	1F	13	1300 ~ 1400										
								14	1400 ~ 1500										
								15	1500 ~ 1600										
								16	1600 ~ 1700										
								17	1700 ~ 1800										
								13	1300 ~ 1400										
3000		SPHWW1HDNA25YHW31F	YH	W3	WA, WB	1F	14	1400 ~ 1500											
							15	1500 ~ 1600											
							16	1600 ~ 1700											
							17	1700 ~ 1800											
							16	1600 ~ 1700											
							17	1700 ~ 1800											
3500		SPHWW1HDNA25YHW21D	YH	W2	WB	1D	16	1600 ~ 1700											
							17	1700 ~ 1800											
							SPHWW1HDNA25YHW31Dd	YH	W3	WA, WB	1D	16	1600 ~ 1700						
												17	1700 ~ 1800						
												3000	SPHWW1HDNA25YHV21F	YH	V2	VB	1F	13	1350 ~ 1450
																		14	1450 ~ 1550
15	1550 ~ 1650																		
16	1650 ~ 1750																		
17	1750 ~ 1850																		
13	1350 ~ 1450																		
3500	SPHWW1HDNA25YHV31F	YH	V3	VA, VB	1F	14	1450 ~ 1550												
						15	1550 ~ 1650												
						16	1650 ~ 1750												
						17	1750 ~ 1850												
						16	1650 ~ 1750												
						17	1750 ~ 1850												
3500	SPHWW1HDNA25YHV21D	YH	V2	VB	1D	16	1650 ~ 1750												
						17	1750 ~ 1850												
						SPHWW1HDNA25YHV31D	YH	V3	VA, VB	1D	16	1650 ~ 1750							
											17	1750 ~ 1850							
											3500	SPHWW1HDNA25YHU21F	YH	U3	UB	1F	14	1400 ~ 1510	
																	15	1510 ~ 1620	
16	1620 ~ 1730																		
17	1730 ~ 1840																		
18	1840 ~ 1950																		

a) Binning Structure ( $I_F = 360 \text{ mA}$ ,  $T_c = 25 \text{ }^\circ\text{C}$ )

CRI ( $R_a$ ) Min.	Nominal CCT (K)	Product Code	$V_f$ Rank	Color Rank	Chrom. Bin	Flux Rank	Flux Bin	Flux Range ( $\Phi_v$ , lm)												
80	3500	SPHWW1HDNA25YHU31F	YH	U3	UA, UB	1F	14	1400 ~ 1510												
							15	1510 ~ 1620												
							16	1620 ~ 1730												
							17	1730 ~ 1840												
							18	1840 ~ 1950												
							17	1730 ~ 1840												
	3500	SPHWW1HDNA25YHU21D	YH	U3	UB	1D	18	1840 ~ 1950												
							17	1730 ~ 1840												
							3500	SPHWW1HDNA25YHU31D	YH	U3	UA, UB	1D	17	1730 ~ 1840						
													18	1840 ~ 1950						
													4000	SPHWW1HDNA25YHT21F	YH	T2	TB	1F	15	1430 ~ 1540
																			16	1540 ~ 1650
	17	1650 ~ 1760																		
	18	1760 ~ 1870																		
	19	1870 ~ 1980																		
	15	1430 ~ 1540																		
	4000	SPHWW1HDNA25YHT31F	YH	T3	TA, TB	1F	16	1540 ~ 1650												
							17	1650 ~ 1760												
							18	1760 ~ 1870												
							19	1870 ~ 1980												
							4000	SPHWW1HDNA25YHT21D	YH	T2	TB	1D	18	1760 ~ 1870						
													19	1870 ~ 1980						
	4000	SPHWW1HDNA25YHT31D	YH	T3	TA, TB	1D							18	1760 ~ 1870						
													19	1870 ~ 1980						
5000													SPHCW1HDNA25YHR31F	YH	R3	RA	1F	15	1440 ~ 1560	
																		16	1560 ~ 1680	
							17	1680 ~ 1800												
							18	1800 ~ 1920												
	5000	SPHCW1HDNA25YHRT1F	YH	RT	RW, RX, RY, RZ	1F	15	1440 ~ 1560												
							16	1560 ~ 1680												
17							1680 ~ 1800													
18							1800 ~ 1920													
5000							SPHCW1HDNA25YHR31D	YH	R3	RA	1D	17	1680 ~ 1800							
												18	1800 ~ 1920							
	5000	SPHCW1HDNA25YHRT1D	YH	RT	RW, RX, RY, RZ	1D						17	1680 ~ 1800							
												18	1800 ~ 1920							
												5700	SPHCW1HDNA25YHQT1F	YH	QT	QW, QX, QY, QZ	1F	15	1440 ~ 1560	
																		16	1560 ~ 1680	
17							1680 ~ 1800													
18							1800 ~ 1920													
5700	SPHCW1HDNA25YHQT1D	YH	QT	QW, QX, QY, QZ	1D	17	1680 ~ 1800													
						18	1800 ~ 1920													



## a) Binning Structure (IF = 360 mA, Tc = 25 °C)

CRI (R <sub>a</sub> ) Min.	Nominal CCT (K)	Product Code	V <sub>f</sub> Rank	Color Rank	Chrom. Bin	Flux Rank	Flux Bin	Flux Range (Φ <sub>v</sub> , lm)
90	2700	SPHWW1HDNA27YHW31F	YH	W3	WB	1F	12	1175 ~ 1290
							13	1290 ~ 1405
							14	1405 ~ 1520
		SPHWW1HDNA27YHW21F	YH	W2	WA, WB	1F	12	1175 ~ 1290
							13	1290 ~ 1405
							14	1405 ~ 1520
	3000	SPHWW1HDNA27YHV21F	YH	V2	VB	1F	12	1200 ~ 1320
							13	1320 ~ 1440
							14	1440 ~ 1560
		SPHWW1HDNA27YHV31F	YH	V3	VA, VB	1F	12	1200 ~ 1320
							13	1320 ~ 1440
							14	1440 ~ 1560
	3500	SPHWW1HDNA27YHU21F	YH	U2	UB	1F	12	1235 ~ 1355
							13	1355 ~ 1475
							14	1475 ~ 1595
		SPHWW1HDNA27YHU31F	YH	U3	UA, UB	1F	12	1235 ~ 1355
							13	1355 ~ 1475
							14	1475 ~ 1595
	4000	SPHWW1HDNA27YHT21F	YH	T2	TB	1F	12	1270 ~ 1395
							13	1395 ~ 1520
							14	1520 ~ 1645
		SPHWW1HDNA27YHT31F	YH	T3	TA, TB	1F	12	1270 ~ 1395
							13	1395 ~ 1520
							14	1520 ~ 1645

**a) Binning Structure (I<sub>F</sub> = 360 mA, T<sub>c</sub> = 25 °C)**

CRI (R <sub>a</sub> ) Min.	Nominal CCT (K)	Product Code	V <sub>f</sub> Rank	Color Rank	Chrom. Bin	Flux Rank	Flux Bin	Flux Range (Φ <sub>v</sub> , lm)
95	2700	SPHWW1HDNA28YHW21E	YH	W2	WB	1E	11	1160 ~ 1289
							12	1289 ~ 1418
		SPHWW1HDNA28YHW31E	YH	W3	WA,WB	1E	11	1160 ~ 1289
							12	1289 ~ 1418
	3000	SPHWW1HDNA28YHV21E	YH	V2	VB	1E	11	1169 ~ 1329
							12	1329 ~ 1462
		SPHWW1HDNA28YHV31E	YH	V3	VA,VB	1E	11	1169 ~ 1329
							12	1329 ~ 1462
	3500	SPHWW1HDNA28YHU21E	YH	U2	UB	1E	11	1232 ~ 1369
							12	1369 ~ 1506
		SPHWW1HDNA28YHU31E	YH	U3	UA,UB	1E	11	1232 ~ 1369
							12	1369 ~ 1506

b) Chromaticity Region & Coordinates ( $I_F = 360 \text{ mA}$ ,  $T_a = 25 \text{ }^\circ\text{C}$ )

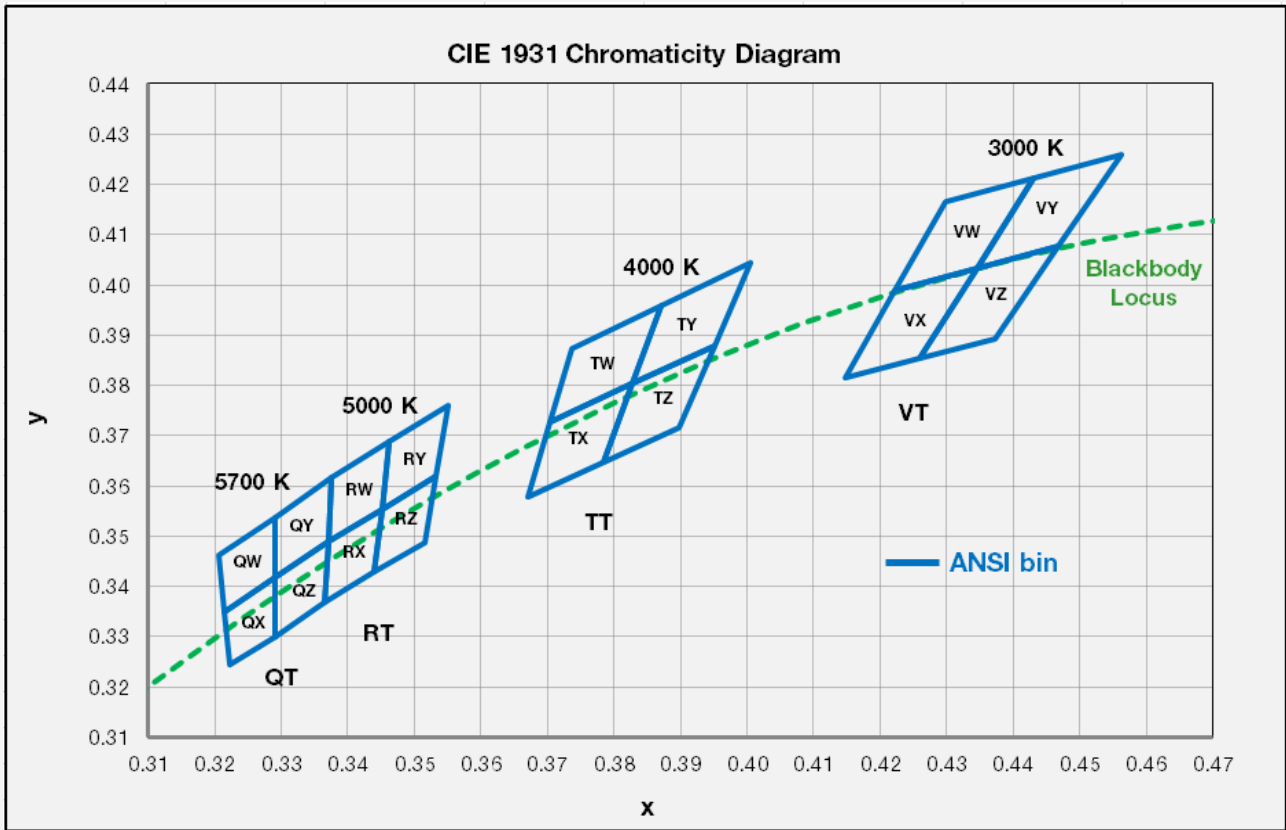

Region	CIE x	CIE y	Region	CIE x	CIE y
<b>V rank (3000 K)</b>					
VW	0.4223	0.399	VY	0.4345	0.4033
	0.4345	0.4033		0.4468	0.4077
	0.4431	0.4213		0.4562	0.4260
	0.4299	0.4165		0.4431	0.4213
VX	0.4223	0.399	VZ	0.4260	0.3854
	0.4147	0.3814		0.4373	0.3893
	0.4260	0.3854		0.4468	0.4077
	0.4345	0.4033		0.4345	0.4033
<b>R rank (5000 K)</b>					
RW	0.3376	0.3616	RY	0.3463	0.3687
	0.3463	0.3687		0.3551	0.3760
	0.3451	0.3554		0.3533	0.3620
	0.3371	0.3490		0.3451	0.3554
RX	0.3371	0.3490	RZ	0.3451	0.3554
	0.3451	0.3554		0.3533	0.3620
	0.3440	0.3428		0.3515	0.3487
	0.3366	0.3369		0.3440	0.3428

Region	CIE x	CIE y	Region	CIE x	CIE y
<b>T rank (4000 K)</b>					
TW	0.3736	0.3874	TY	0.3871	0.3959
	0.3871	0.3959		0.4006	0.4044
	0.3828	0.3803		0.3952	0.388
	0.3703	0.3726		0.3828	0.3803
TX	0.3703	0.3726	TZ	0.3828	0.3803
	0.3828	0.3803		0.3952	0.388
	0.3784	0.3647		0.3898	0.3716
	0.367	0.3578		0.3784	0.3647
<b>Q rank (5700 K)</b>					
QW	0.3207	0.3462	QY	0.3290	0.3538
	0.3290	0.3538		0.3376	0.3616
	0.3290	0.3417		0.3371	0.3490
	0.3215	0.3350		0.3290	0.3417
QX	0.3215	0.3350	QZ	0.3290	0.3417
	0.3290	0.3417		0.3371	0.3490
	0.3290	0.3300		0.3366	0.3369
	0.3222	0.3243		0.3290	0.3300

b) Chromaticity Region & Coordinates ( $I_F = 360 \text{ mA}$ ,  $T_a = 25 \text{ }^\circ\text{C}$ )

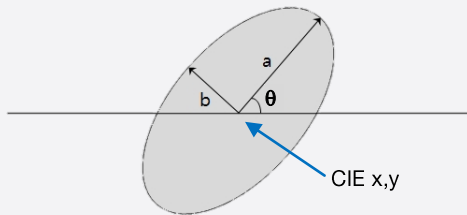
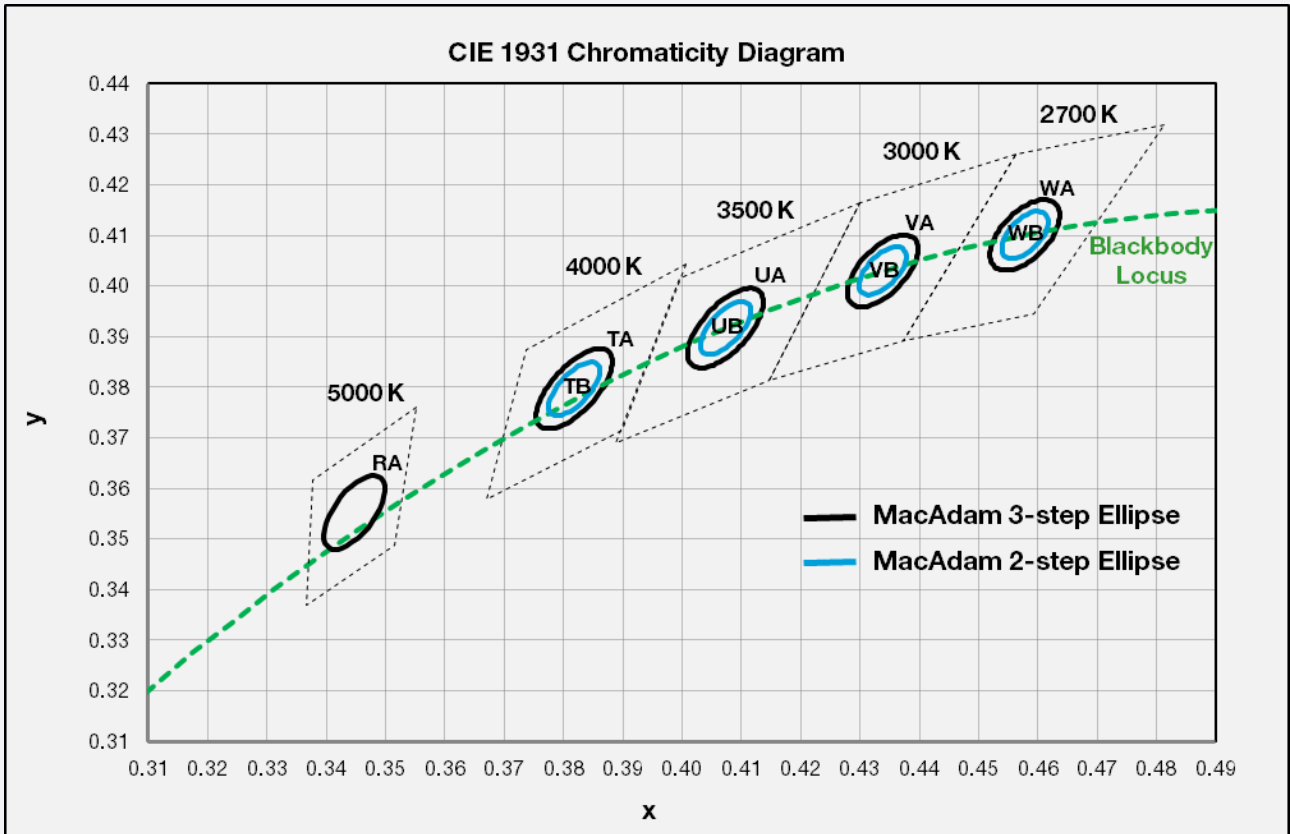

MacAdam Ellipse (WA, WB)					
Step	CIE x	CIE y	$\theta$	a	b
2-step	0.4578	0.4101	53.70	0.0054	0.0028
3-step	0.4578	0.4101	53.70	0.0081	0.0042

MacAdam Ellipse (VA, VB)					
Step	CIE x	CIE y	$\theta$	a	b
2-step	0.4338	0.403	53.22	0.0056	0.0027
3-step	0.4338	0.4030	53.22	0.0083	0.0041

MacAdam Ellipse (UA, UB)					
Step	CIE x	CIE y	$\theta$	a	b
2-step	0.4073	0.3917	54.00	0.0062	0.0028
3-step	0.4073	0.3917	54.00	0.0093	0.0041

MacAdam Ellipse (TA, TB)					
Step	CIE x	CIE y	$\theta$	a	b
2-step	0.3818	0.3797	53.72	0.0063	0.0027
3-step	0.3818	0.3797	53.72	0.0094	0.0040

MacAdam Ellipse (RA)					
Step	CIE x	CIE y	$\theta$	a	b
3-step	0.3447	0.3553	59.62	0.0082	0.0035

**Note:**

Samsung maintains measurement tolerance of:  $C_x, C_y = \pm 0.005$



### 3. Typical Characteristics Graphs

#### a) Spectrum Distribution ( $I_f = 360 \text{ mA}$ , $T_c = 25 \text{ }^\circ\text{C}$ )

CCT: 2700 K (80 CRI)

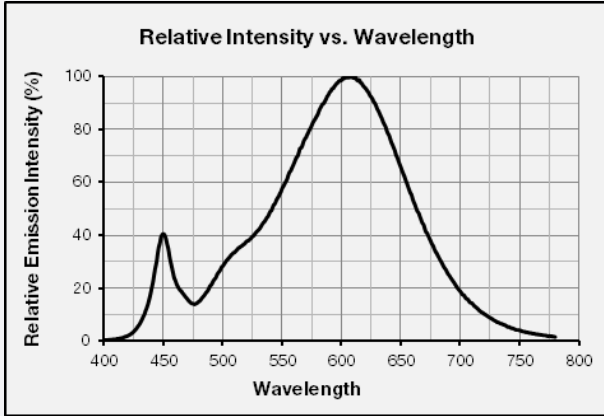

CCT: 3000 K (80 CRI)

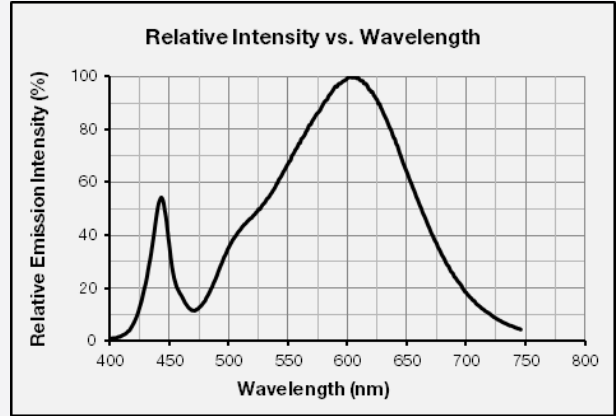

CCT: 3500 K (80 CRI)

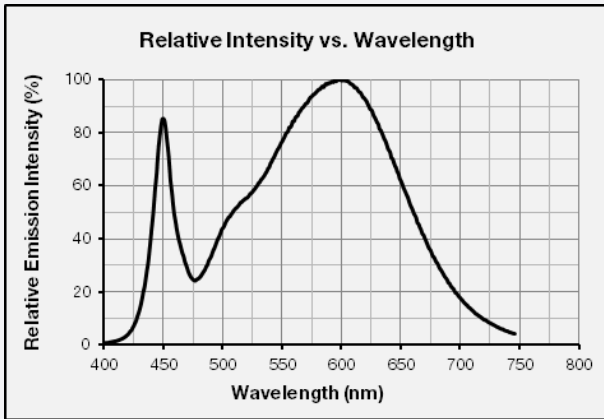

CCT: 4000 K (80 CRI)

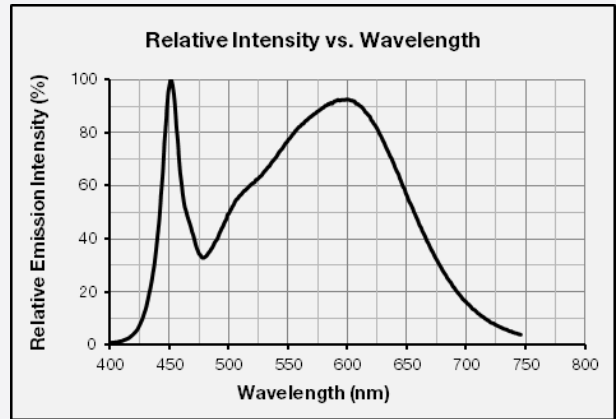

CCT: 5000 K (80 CRI)

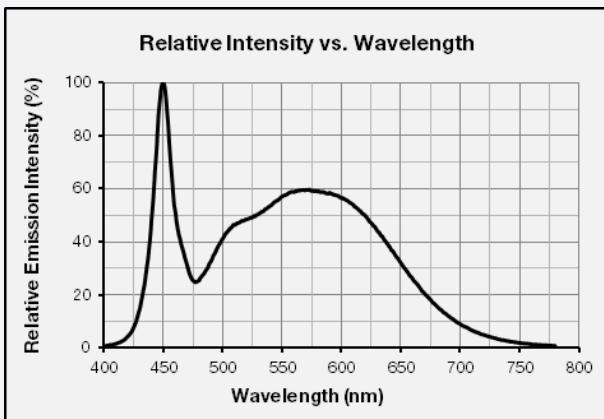

CCT: 5700 K (80 CRI)

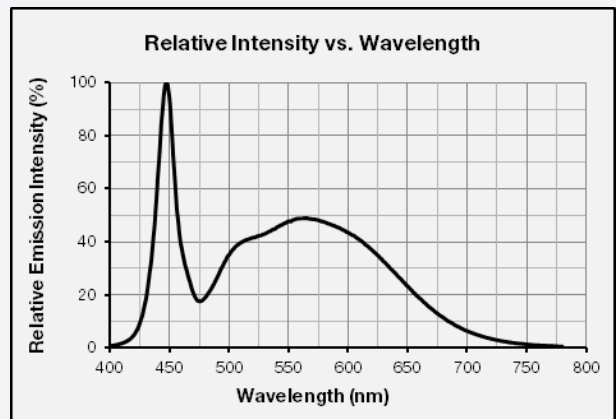

CCT: 2700 K (90 CRI)

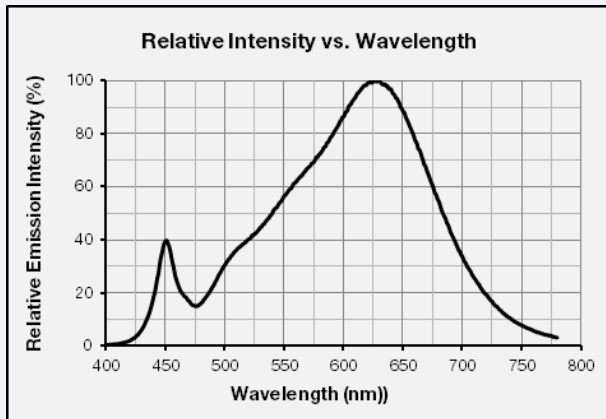

CCT: 3000 K (90 CRI)

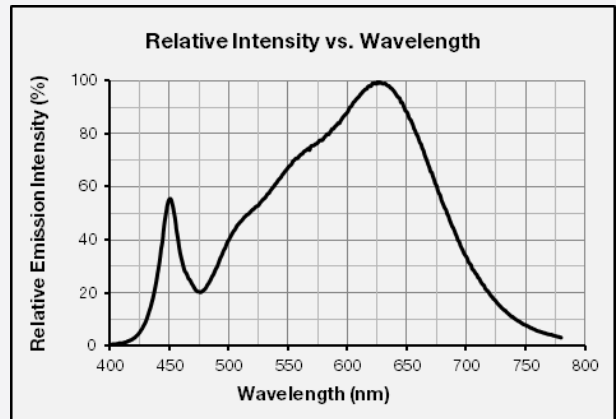

CCT: 3500 K (90 CRI)

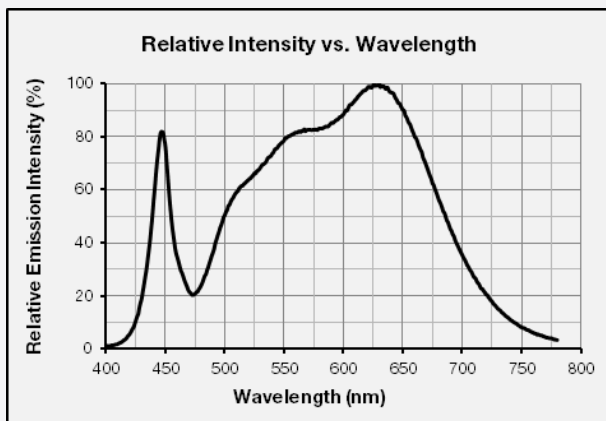

CCT: 4000 K (90 CRI)

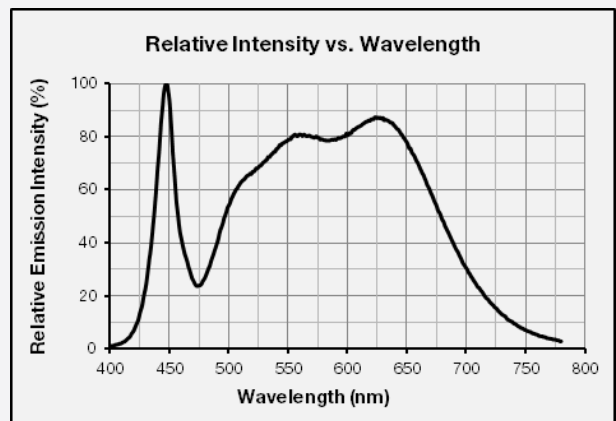

**b) Forward Current Characteristics (T<sub>c</sub> = 25 °C)**

80 CRI

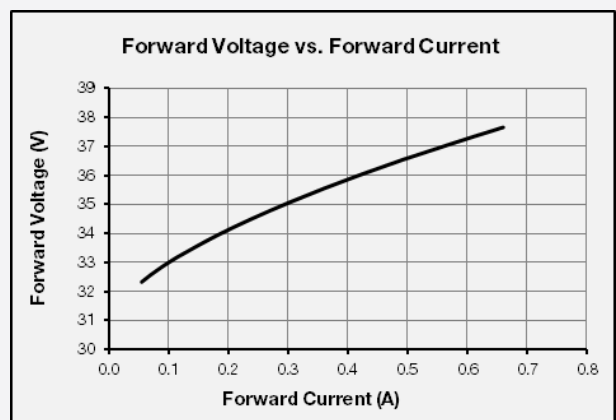
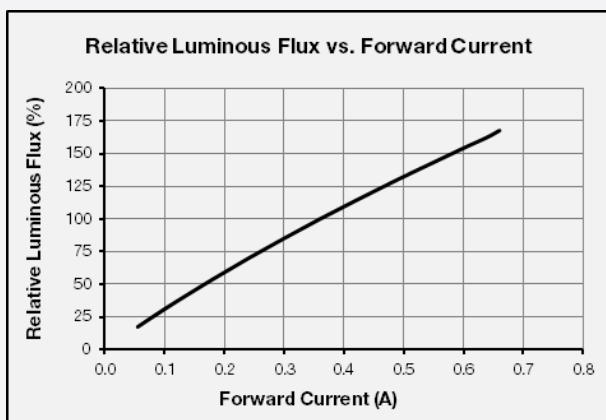

90 CRI

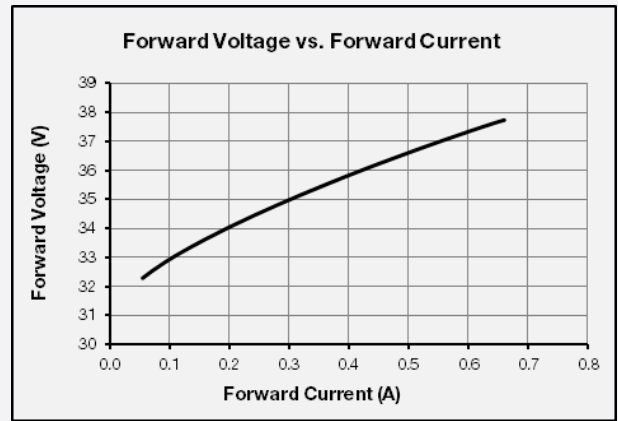
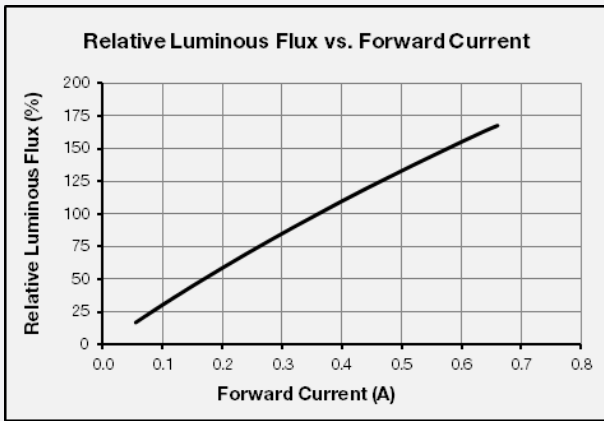

c) Temperature Characteristics (I<sub>F</sub> = 360 mA)

80 CRI

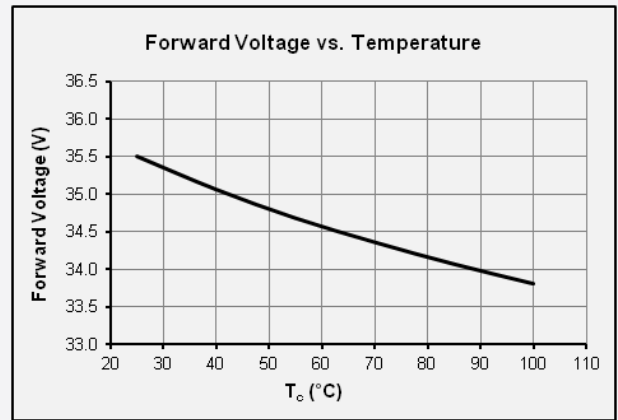
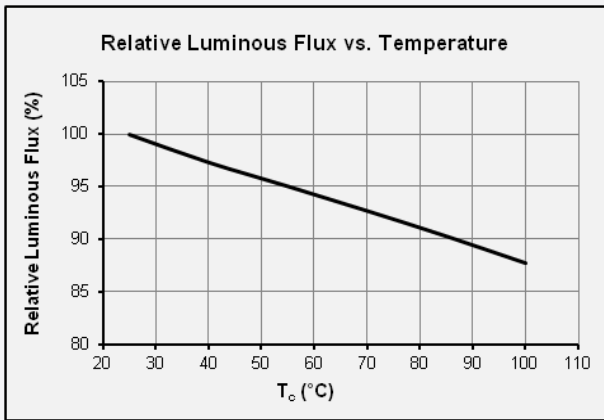

90 CRI

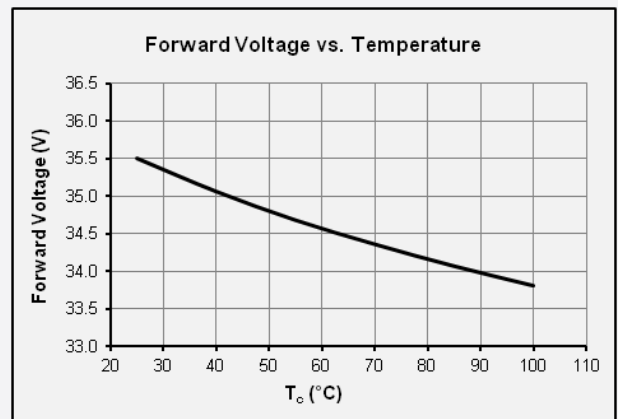
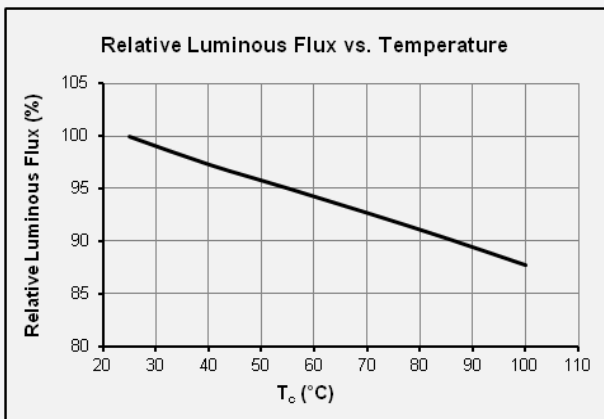

d) Color Shift Characteristics

$T_c = 25^\circ\text{C}$

$I_F = 360\text{ mA}$

80 CRI

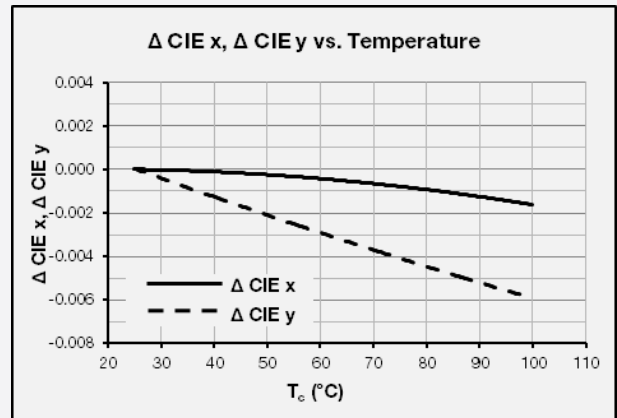
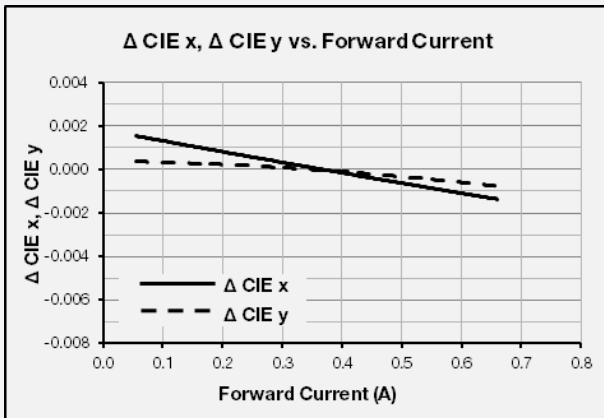

90 CRI

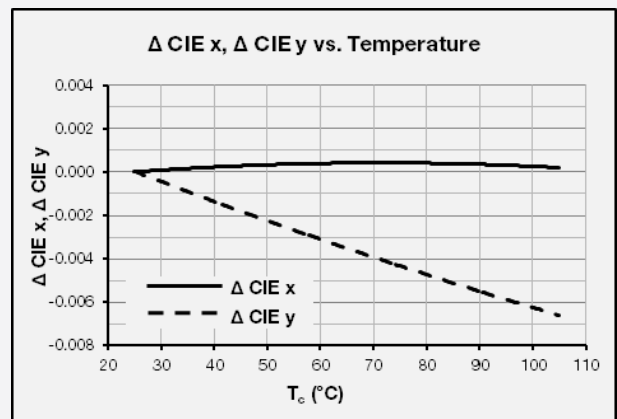
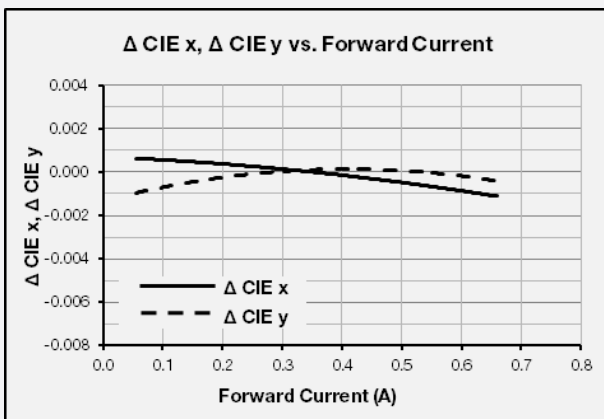

e) Derating Curve

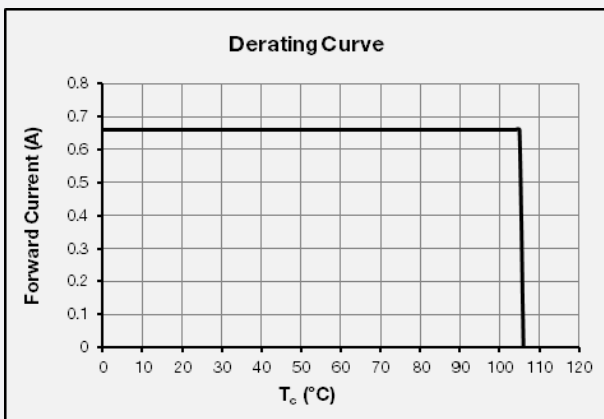



**f) Beam Angle Characteristics ( $I_F = 360 \text{ mA}$ ,  $T_C = 25 \text{ }^\circ\text{C}$ )**

80 CRI

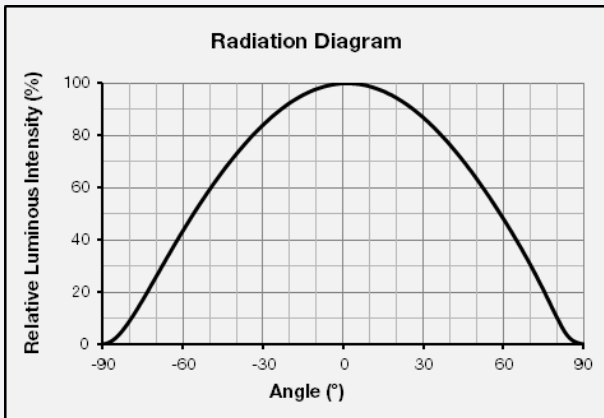

90 CRI

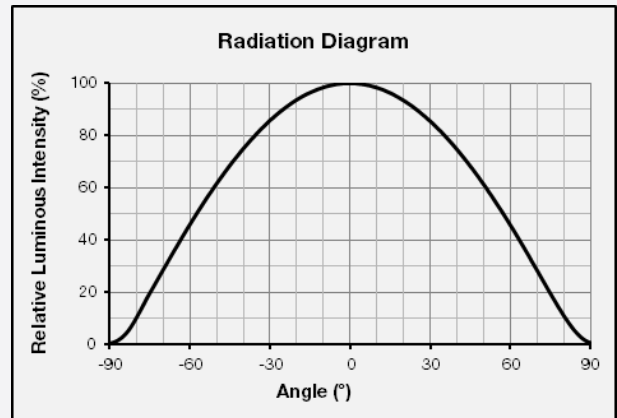

#### 4. Outline Drawing & Dimension

1. Unit: mm
2. Tolerance:  $\pm 0.15$  mm

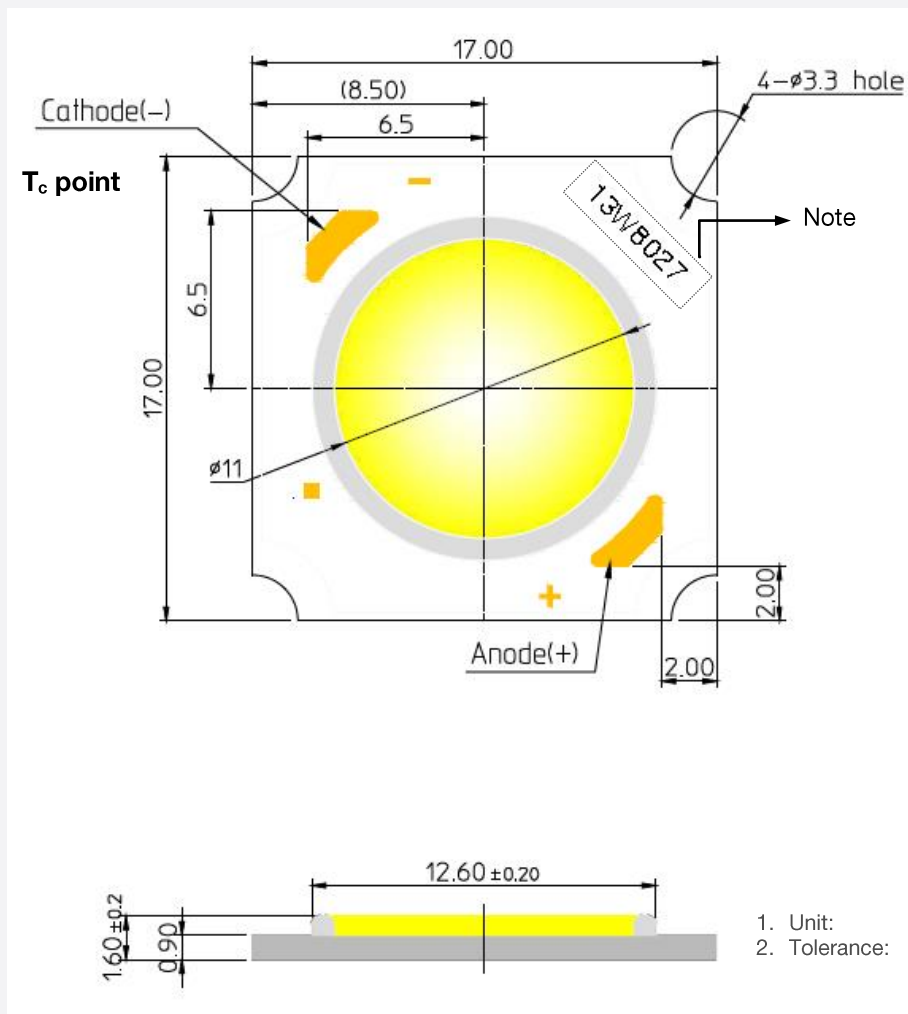

1. Unit: mm
2. Tolerance:  $\pm 0.2$  mm

Item	Dimension	Tolerance	Unit
Length	17.0	$\pm 0.15$	mm
Width	17.0	$\pm 0.15$	mm
Height	1.50	$\pm 0.20$	mm
Light Emitting Surface (LES) Diameter	11	$\pm 0.15$	mm

Note: Denoted product information above is only an example  
( 13W8027 : 13W, CRI80+, 2700K )

## 5. Reliability Test Items & Conditions

### a) Test Items

Test Item	Test Condition	Test Hour / Cycle
Room Temperature Life Test	25 °C, $I_F = \text{max}$	1000 h
High Temperature Humidity Life Test	85 °C, 85 % RH, DC Derating, $I_F = \text{max}$	1000 h
High Temperature Life Test	105 °C, DC Derating, $I_F = \text{max}$	1000 h
Low Temperature Life Test	-40 °C, DC 660 mA	1000 h
High Temperature Storage	120 °C	1000 h
Low Temperature Storage	-40 °C	1000 h
Thermal Shock	-45 °C / 15 min ↔ 125 °C / 15 min temperature change in 5 min	200 cycles
Temperature Cycle On/Off Test	-40 °C / 85 °C each 20 min, 100 min transfer power on/off each 5 min, DC 360 mA	100 cycles
Temperature Humidity Storage Test	-10 °C ↔ 25 °C, 95 % RH ↔ 85 °C, 95 % RH (24 h / cycle)	100 cycles
ESD (HBM)	$R_1$ : 10 M $\Omega$ $R_2$ : 1.5 k $\Omega$ C: 100 pF V: ±2 kV	5 times
ESD (MM)	$R_1$ : 10 M $\Omega$ $R_2$ : 0 k $\Omega$ C: 200 pF V: ±0.5 kV	5 times
Vibration Test	20 ~ 80 Hz (displacement: 0.06 inch, max. 20 g) 80 ~ 2 kHz (max. 20 g) min. frequency ↔ max. frequency 4 min transfer	4 times
Mechanical Shock Test	1500 g, 0.5 ms each of the 6 surfaces (3 axis x 2 sides)	5 times
Salt Spray Test	35 °C, 5 % salt water 8 h spray, 16 h dwell	2 cycles

### b) Criteria for Judging the Damage

Item	Symbol	Test Condition ( $T_c = 25\text{ °C}$ )	Limit	
			Min.	Max.
Forward Voltage	$V_F$	$I_F = 360\text{ mA}$	L.S.L. * 0.9	U.S.L. * 1.1
Luminous Flux	$\Phi_v$	$I_F = 360\text{ mA}$	L.S.L. * 0.7	U.S.L. * 1.3

## 6. Label Structure

### a) Label Structure

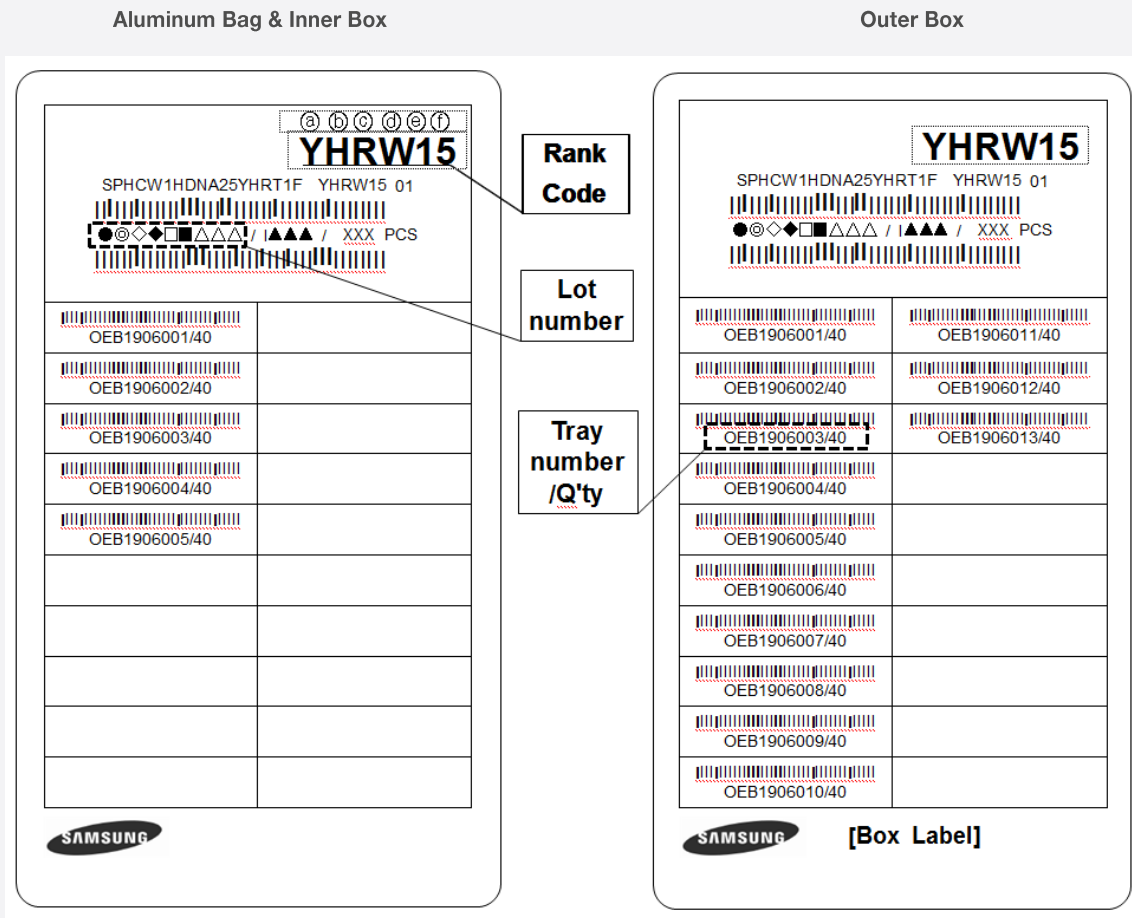

Note: Denoted rank code and product code above is only an example (see description on page 6)

Rank Code:

- ⒶⒷ: Forward Voltage rank (refer to page 7-10)
- ⒸⒹ: Chromaticity bin (refer to page 11-12)
- ⒺⒻ: Luminous Flux bin (refer to page 7-10)

## b) Lot Number

The lot number is composed of the following characters:

●◎◇◆□■△△△ / 1▲▲▲ / xxx PCS

- : Production site (S: Korea, G: Tianjin, China)
- ◎ : L (LED)
- ◇ : Product state (A: Normal, B: Bulk, C: First Production, R: Reproduction, S: Sample)
- ◆ : Year (Y: 2014, Z: 2015, A: 2016, ...)
- : Month (1~9, A, B, C)
- : Day (1~9, A, B~V)
- △△△ : Product serial number (001 ~ 009)
- ▲▲▲ : Tray number (001 ~ 999)

## 7. Packing Structure

Packing material	Max. quantity in pcs of COB	Dimension (mm)			
		Length	Width	Height	Tolerance
Tray	90	322.6	135.9	11	0.25
Aluminum Bag	450 (5 trays)	450	230	-	10
PE Foam Pad	-	280	130	10	2
Inner Box	450 (1 aluminum bag)	338	148	55	2
Outer Box	1800 (4 inner boxes)	351	308	120	5
Pallet	100,800 (56 outer boxes)	1000	1000	970	10

### a) Packing Structure for 5 trays inside Aluminum Bag

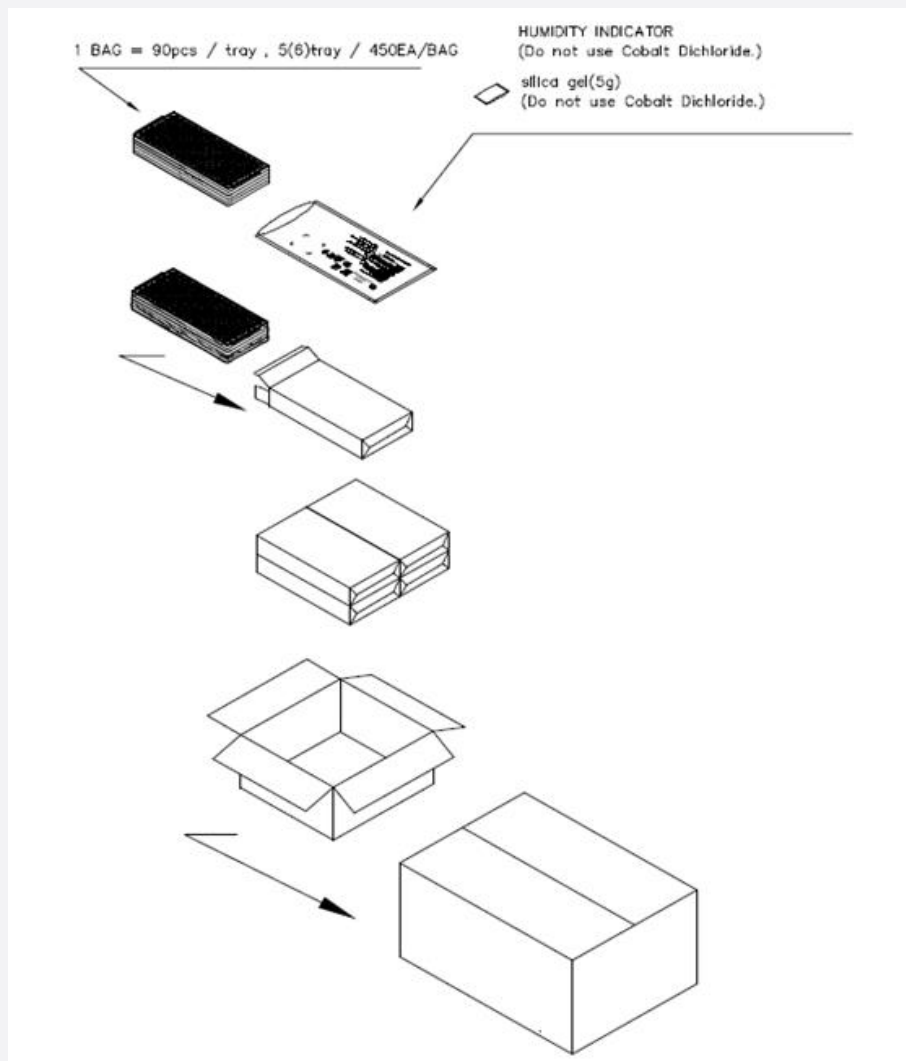

b) Packing Structure for <5 trays inside Aluminum Bag

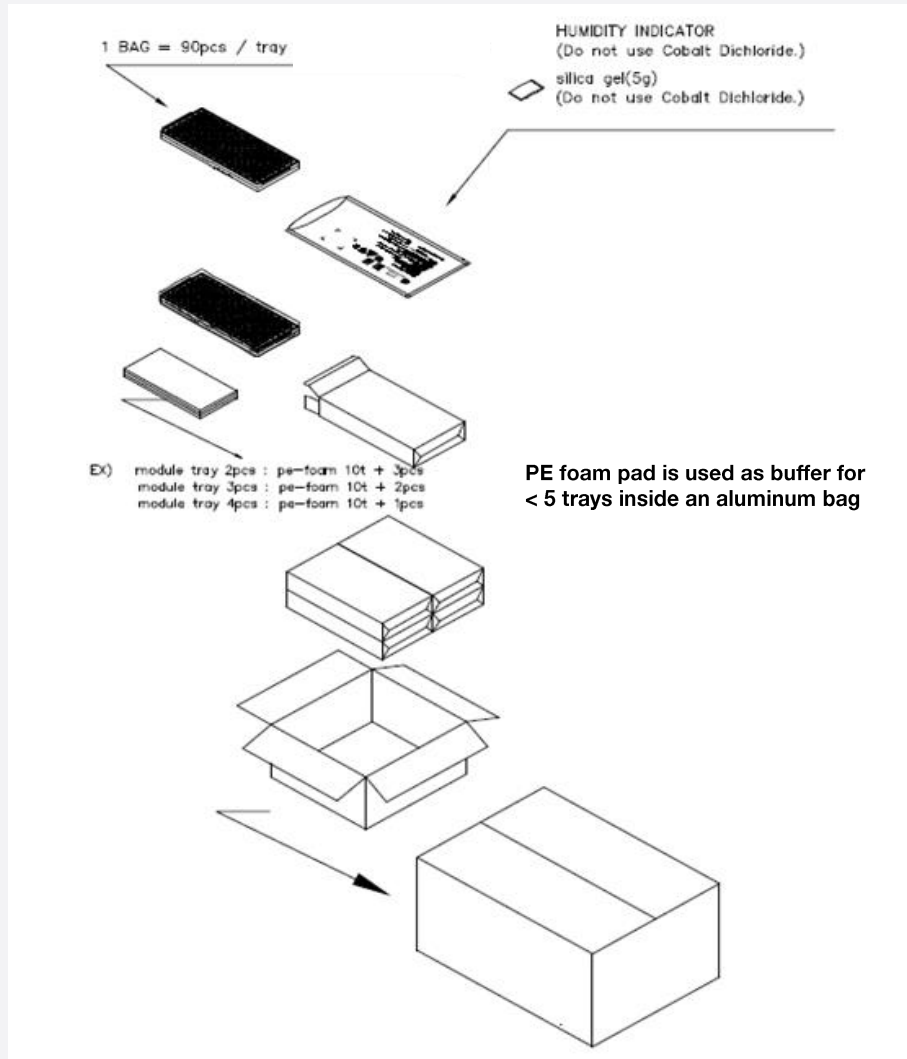

c) Tray

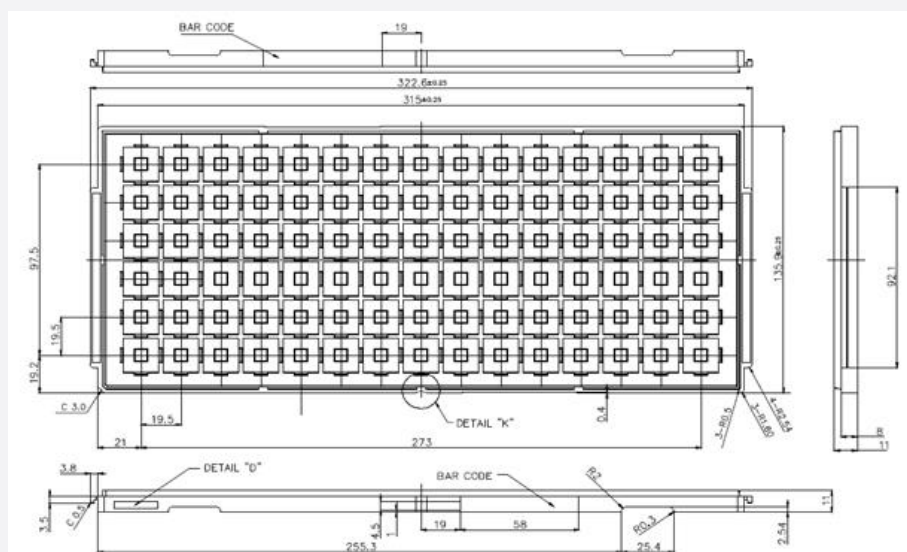

d) Aluminum Vinyl Packing Bag

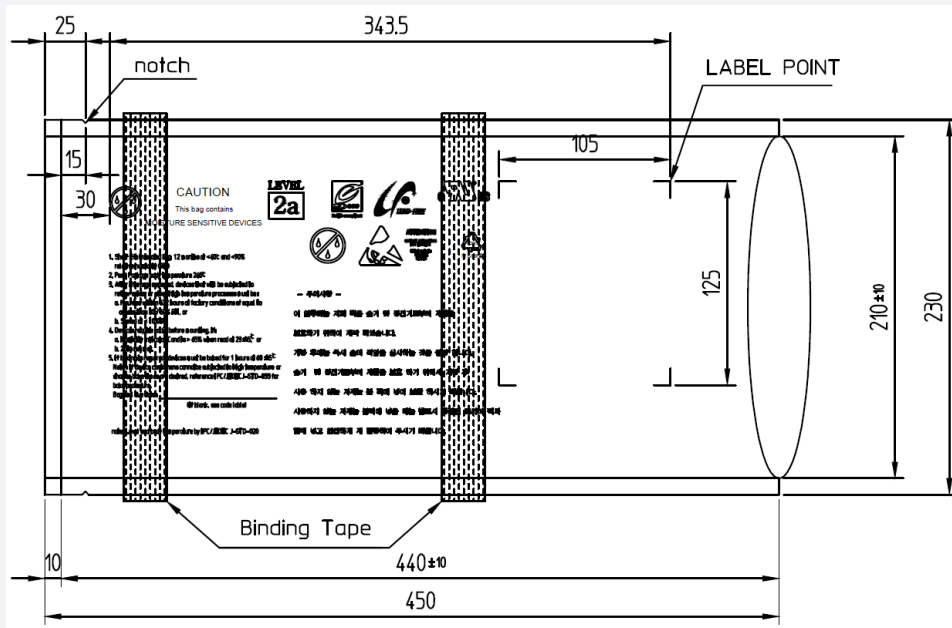

e) Silica Gel & Humidity Indicator Card inside Aluminum Vinyl Packing Bag

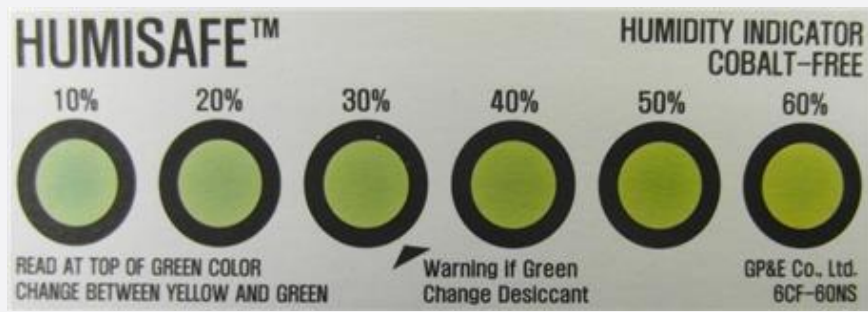



## 8. Precautions in Handling & Use

- 1) This device should not be used in any type of fluid such as water, oil, organic solvent, etc. When cleaning is required, IPA is recommended as the cleaning agent. Some solvent-based cleaning agent may damage the silicone resins used in the device.
- 2) LEDs must be stored in a clean environment. If the LEDs are to be stored for three months or more after being shipped from Samsung, they should be packed with a nitrogen-filled container (shelf life of sealed bags is 12 months at temperature 0~40 °C, 0~90 % RH).
- 3) After storage bag is opened, device subjected to soldering, solder reflow, or other high temperature processes must be:
  - a. Mounted within 672 hours (28 days) at an assembly line with a condition of no more than 30 °C / 60 % RH, or
  - b. Stored at <10 % RH
- 4) Repack unused products with anti-moisture packing, fold to close any opening and then store in a dry place.
- 5) Devices require baking before mounting, if humidity card reading is >60 % at 23 ± 5 °C.
- 6) Devices must be baked for 1 hour at 60 ± 5 °C, if baking is required.
- 7) The LEDs are sensitive to the static electricity and surge current. It is recommended to use a wrist band or anti-electrostatic glove when handling the LEDs. If voltage exceeding the absolute maximum rating is applied to LEDs, it may cause damage or even destruction to LED devices. Damaged LEDs may show some unusual characteristics such as increase in leakage current, lowered turn-on voltage, or abnormal lighting of LEDs at low current.
- 8) VOCs (Volatile Organic Compounds) can be generated from adhesives, flux, hardener or organic additives used in luminaires (fixtures). Transparent LED silicone encapsulant is permeable to those chemicals and they may lead to a discoloration of encapsulant when they exposed to heat or light. This phenomenon can cause a significant loss of light emitted (output) from the luminaires. In order to prevent these problems, we recommend users to know the physical properties of materials used in luminaires and they must be carefully selected.
- 9) The resin area is very sensitive, please do not handle, press, touch, rub, clean, or pick by with tweezers on it. Instead, please pick at the handling area as indicated below.

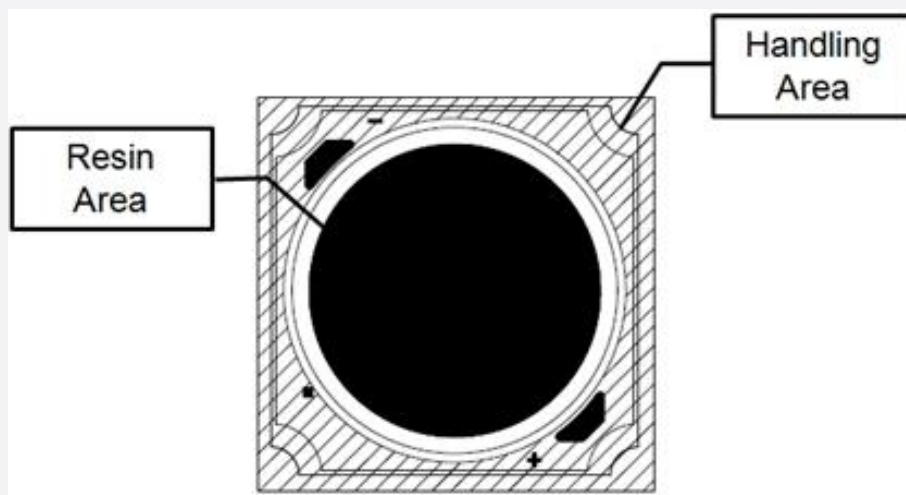

# Legal and additional information.

## [About Samsung Electronics Co., Ltd.](#)

Samsung Electronics Co., Ltd. inspires the world and shapes the future with transformative ideas and technologies, redefining the worlds of TVs, smartphones, wearable devices, tablets, cameras, digital appliances, printers, medical equipment, network systems and semiconductors. We are also leading in the Internet of Things space through, among others, our Digital Health and Smart Home initiatives. We employ 307,000 people across 84 countries. To discover more, please visit our official website at [www.samsung.com](http://www.samsung.com) and our official blog at [global.samsungtomorrow.com](http://global.samsungtomorrow.com).

Copyright © 2015 Samsung Electronics Co., Ltd. All rights reserved.  
Samsung is a registered trademark of Samsung Electronics Co., Ltd.  
Specifications and designs are subject to change without notice. Non-metric weights and measurements are approximate. All data were deemed correct at time of creation. Samsung is not liable for errors or omissions. All brand, product, service names and logos are trademarks and/or registered trademarks of their respective owners and are hereby recognized and acknowledged.

Samsung Electronics Co., Ltd.  
95, Samsung 2-ro  
Giheung-gu  
Yongin-si, Gyeonggi-do, 446-711  
KOREA

[www.samsungled.com](http://www.samsungled.com)

